



INSTALLATION INSTRUCTIONS INSTRUCCIONES DE MONTAJE



Safety instructions / Instrucciones de seguridad

Precautions / Precauciones:

It is important that you read, fully understand and observe the following safety instructions as well as the installation instructions.
Careless or improper handling may cause injury or property damage.



*Es importante que lea, comprenda completamente y respete las siguientes instrucciones de seguridad, así como las instrucciones de montaje.
El manejo descuidado o inadecuado puede causar lesiones o daños a la propiedad.*

Good footwear is very important. Wear sturdy boots with nonslip soles. Steel-toed safety boots are recommended.



Un buen calzado es muy importante. Póngase botas gruesas con suela antideslizante. Recomendamos las botas de seguridad con puntera de acero.

Knee-protection is recommended!



¡Recomendamos la protección de rodilla!

Always wear gloves when handling and installing the mats. Heavy-duty, nonslip gloves improve your grip and help to protect your hands.



Siempre use guantes cuando maneje y monte los pisos de goma. Los guantes gruesos y antideslizantes mejoran el manejo y ayudan a proteger las manos.

During installation / durante el montaje:

Do not stand or work under suspended load (pallet)!



¡No se pare ni trabaje bajo carga suspendida (palet)!

- Do not underestimate the weight of the mats. Improper handling may cause injury.
- Only use the recommended tools.
- Observe the safety instructions of the tools' manufacturers.
- Caution when cutting: blade may move quickly through the rubber mat. Be sure you are cutting away from your body.
- Pallets can be broken! Watch out for splinters and / or nails!
- Take care to remove edge protectors or other small parts of packaging from cow feeding areas!



- *No subestime el peso de los pisos de goma. El manejo inadecuado puede causar lesiones.*
- *Solo use las herramientas recomendadas.*
- *Respete las instrucciones de seguridad de los fabricantes de herramientas.*
- *Tenga cuidado al cortar: la cuchilla puede moverse rápidamente a través del piso de goma. Asegúrese de estar cortando lejos de su cuerpo.*
- *¡Los palets se pueden romper! ¡Cuidado con las astillas y / o los clavos!*
- *¡Tenga cuidado de quitar los protectores de bordes u otras partes pequeñas de los envases de las áreas de alimentación de las vacas!*

After installing / después del montaje:



Caution!
Cows will be more active!

*¡Cuidado!
¡Las vacas podrían ser más activas!*



Watch out for uneven edges if the floor is only partially covered.

Tenga cuidado con los desniveles en los bordes si el piso está cubierto solo parcialmente.



Residues on the rubber may cause slippery condition while and shortly after installing!

¡Los residuos sobre la goma pueden causar condiciones resbalosas durante y poco después del montaje!

KRAIBURG WELA LongLine

Requirements:



concrete area:

- minimum 4" (10 cm) thick
- no holes
- level off uneven surfaces

mats:

Installation Temperature:
minimum 41°F (5°C) to maximum 86°F (30°C) (be sure internal temperature of mats falls within above range)



86°F!
41°F!



for animal hygiene
some bedding is
necessary to absorb
moisture

You will need this:

measuring:

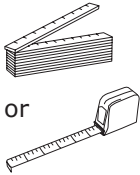

marking:

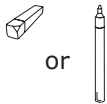

cutting:

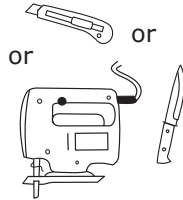

drilling and installing:

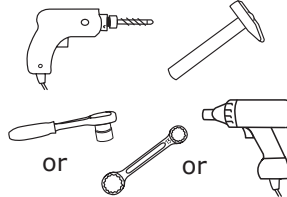

fastening components:

- 3/8" x 4" LDT steel anchors
- 1/2" fender washer

(or fastening components with at least the same resistance and durability)

1 Placement line

74" (188 cm) for mat length 72" (183 cm)
67" (170 cm) for mat length 64" (165 cm)

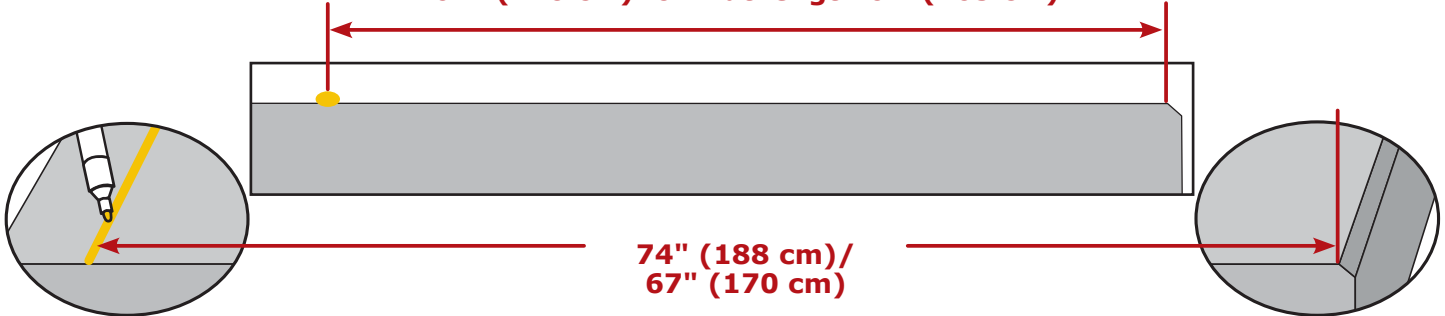

draw placement line in the front

Tip: use a chalk line

measure from the rear
curb edge

2 Roll out & put in place

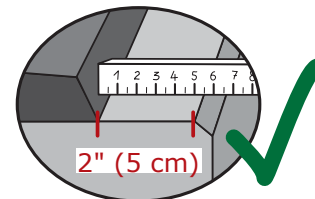
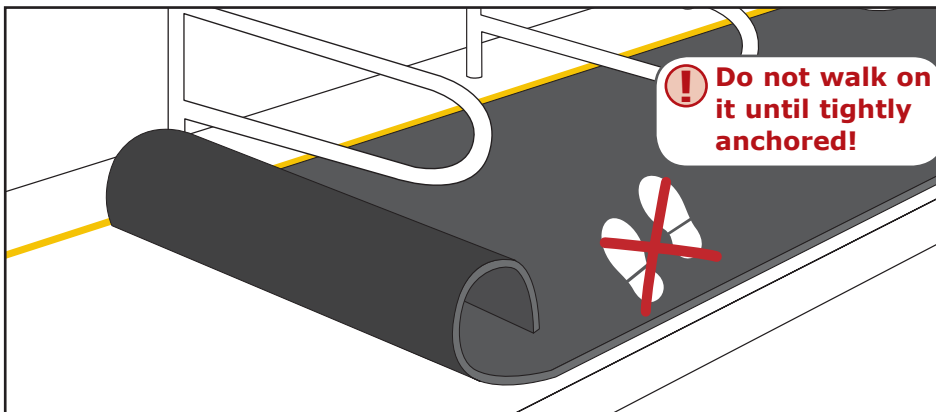

distance from mat to
curb edge: 2" (5 cm)

The distance will decrease considerably within the first days after installation.

! Cutting is not recommended and voids all warranty!

Appropriate installation may differ due to local conditions.
Therefore the manufacturer is not liable for installation!



3 Fastening

i start in the middle and alternately work towards the right and to the left

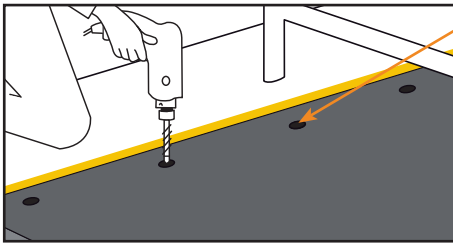

anchor at the front edge through the predrilled holes

! Make sure the front edge of the mat is on the marking. If necessary, readjust.

! 3/8" x 4" LDT steel anchors & 1/2" fender washer

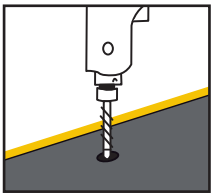

drill

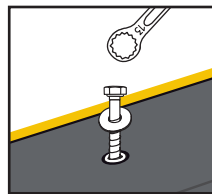

pound in anchors and washers until they are seated firmly and are slightly countersunk. **Do not overtighten!**

4 Fasten ends of mat with termination bar

A Position termination bar

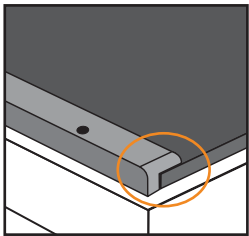

Left WELA Termination Bar

(WELA-L)

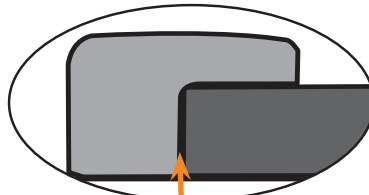

Contact

! DO NOT PRESS!

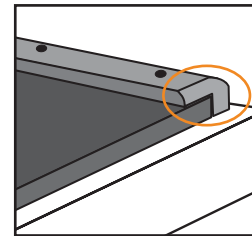

Right WELA Termination Bar

(WELA-R)

- rounded off end to rear
- flush with rear mat edge

B Fasten profiles

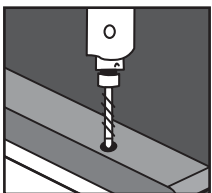

drill

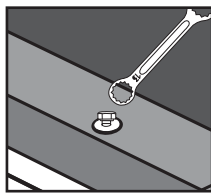

fasten 3/8" x 4" LDT steel anchors and 1/2" fender washer

! 3/8" x 4" LDT steel anchors & 1/2" fender washer

i tip to avoid profile slippage:
 1. drill first hole
 2. turn in LDT loosely
 3. then continue on to remaining holes

5 Optional: connect two rolls with WELA Connector Bar (under a divider)

A Insert WELA connector bar

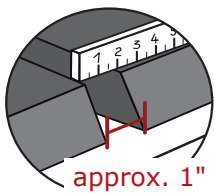

approx. 1" (2 - 2.5 cm)

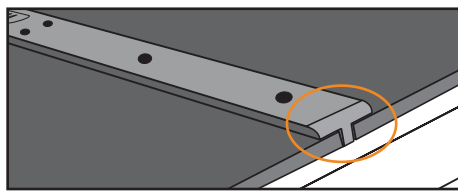

- rounded off end to rear
- flush with rear mat edge

! DO NOT PRESS!

B Fasten profiles: see **4** **B**

Appropriate installation may differ due to local conditions. Therefore the manufacturer is not liable for installation!



KRAIBURG WELA LongLine - US - 2/2019 - I