

KRAIBURG WELA LongLine

Prerequisites:



concrete area:

- no holes
- no elevations
- min. 3 % slope

mats:

even temperature:
min. 5° C to max. 30° C
(store according to initial temperature)

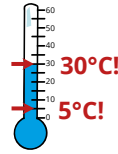

For animal well-being some litter is necessary to absorb moisture (e.g. soft milled straw or mineral material)

You will need this:

measuring:

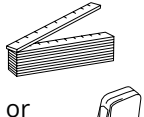

marking:

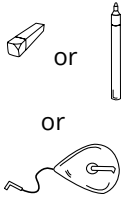

cutting:

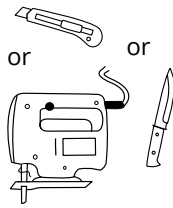

drilling and installing:

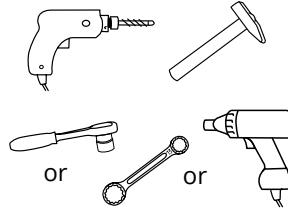

KRAIBURG fastening elements:

- framing plugs \varnothing 10 x 80 mm with
- hexagon screw (SW 13) - A2
- washer \varnothing 40 mm - A2
- framing plugs \varnothing 10 x 100 mm with
- hexagon screw (SW 13) - A2
- washer \varnothing 30 mm - A2

(fastening elements are part of delivery)

1 Placement line

188 cm for mat length 183 cm
175 cm for mat length 170 cm
170 cm for mat length 165 cm

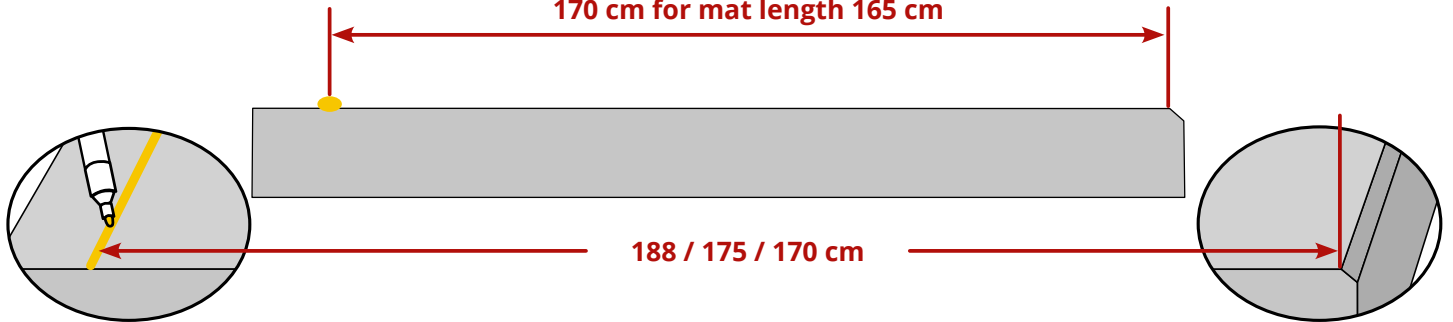

draw placement line in the front

Tip: use a chalk line

measure from the rear concrete edge

2 Roll out / put in place

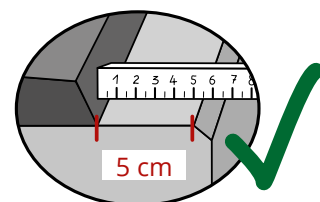
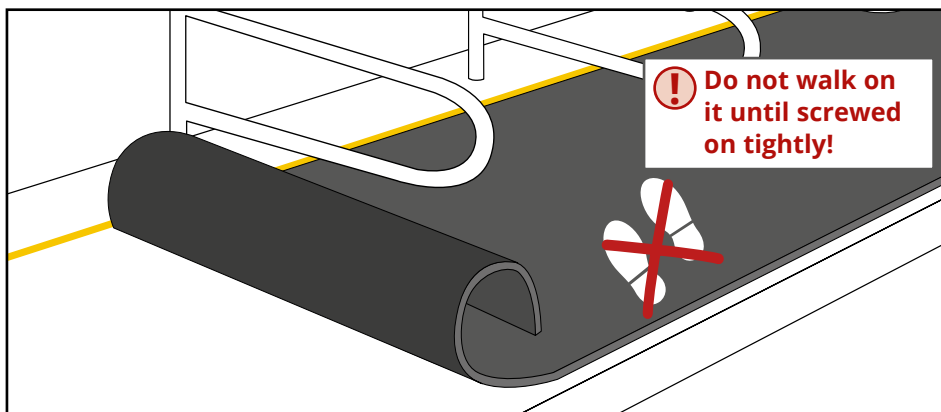

rear concrete edge:
5 cm installation distance!

i The distance will decrease considerably within the first days after installation

! Cutting out pockets for pillars, etc. is not possible!

3 Fastening

i Start from the middle of the roll and fasten to the right and to the left

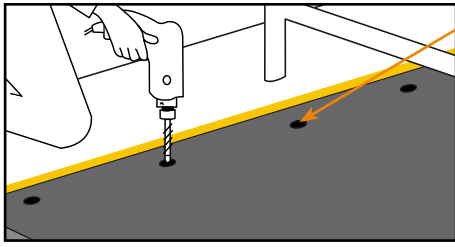

fasten at the front edge through the pre-fabricated fastening points

! Make sure the front edge of the mat is on the marking. If necessary, readjust.

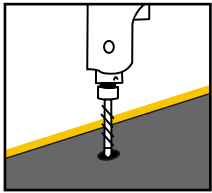
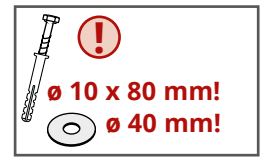

drill

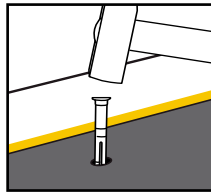

pound the plastic plugs in flush

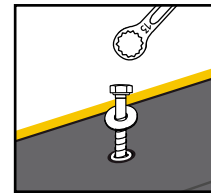

fasten screws and washers

! Fasten screws until they are seated evenly fast and are slightly countersunk. **Do not overtighten!**

4 Fasten side mat edge with closure profile

A Position profiles

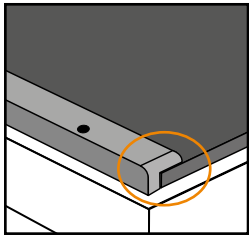

left edge with profile **WELA-L**

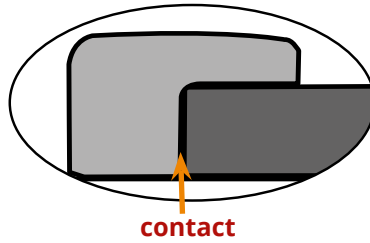

contact

! DO NOT PRESS!

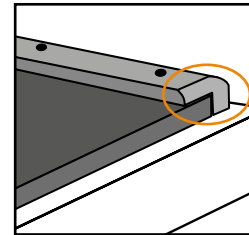

right edge with profile **WELA-R**

- rounded off end on the rear edge
- flush with rear mat edge

B Fasten profiles

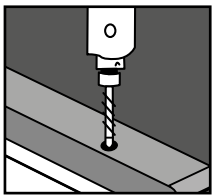

drill

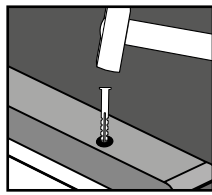

pound the plastic plugs in flush

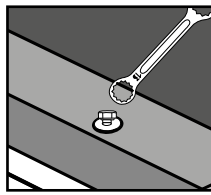

fasten screws and washers until they are seated evenly fast; **do not overtighten!**

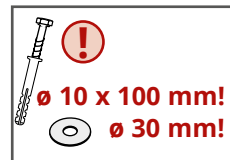

i **Tip: avoid slippage:**

- fix at one fastening point
- afterwards drill further holes and so on

5 Optional: connect two rolls with a middle profile (under a divider)

A Insert middle profile **WELA-M**

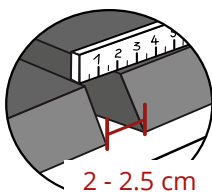

2 - 2.5 cm

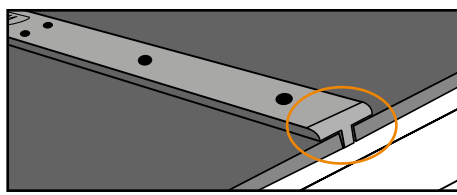

- rounded off end on the rear edge
- flush with rear mat edge

! DO NOT PRESS!

B Fasten profiles: see **4 B**