

KRAIBURG Soft Bed LongLine

Prerequisites:



concrete area:

- no holes
- no elevations
- min. 3 % slope

mats:

even temperature:
min. 5° C to max. 30° C
(store according to initial temperature)

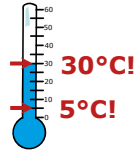

For animal well-being some litter is necessary to absorb moisture! (e.g. soft milled straw or mineral material)

You will need this:

measuring:

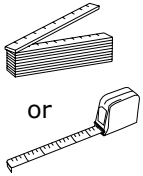

marking:

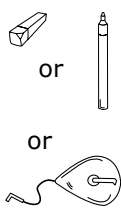

cutting:

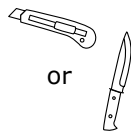

drilling and installing:

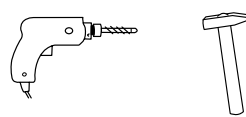

KRAIBURG fastening elements:



nail plugs \varnothing 8 x 60 mm - A2 with washer \varnothing 22 mm - A2
nail plugs \varnothing 10 x 80 mm - A2 with washer \varnothing 30 mm - A2
(or fastening elements with at least the same resistance and durability)

1 Lay out and fasten sealing strips at the rear edge

- > thin, wide sealing strips (11 mm thick, about 20 cm wide)
- > nail plugs \varnothing 8 x 60 mm

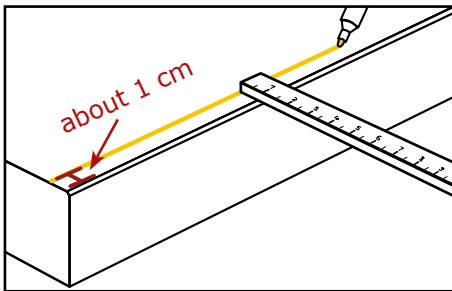

mark a distance of about 1 cm from the rear concrete edge



Tip:
use a chalk line!

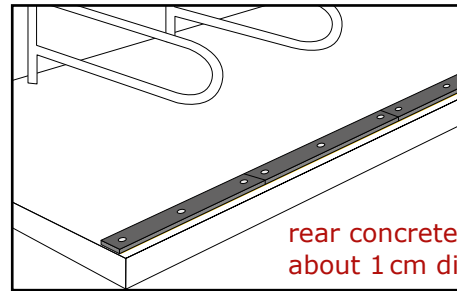

lay out thin, wide sealing strips along the marking

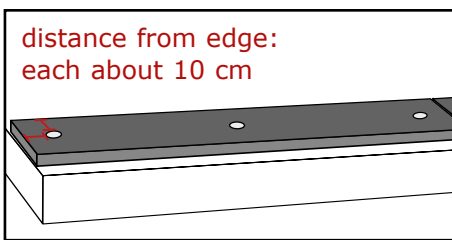
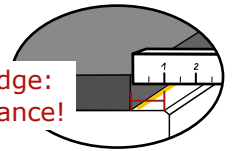

distance from edge:
each about 10 cm

fasten each sealing strip 3 x

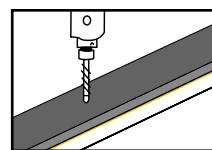
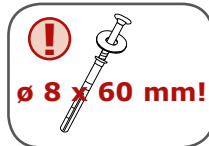

drill

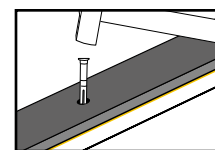

pound the plastic plugs in flush

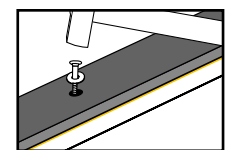

pound in nails and washers

2 Lay out side sealing strips - foam - front sealing strips

- > thick, narrow sealing strips (18 mm thick, about 5 cm wide)
- > foam

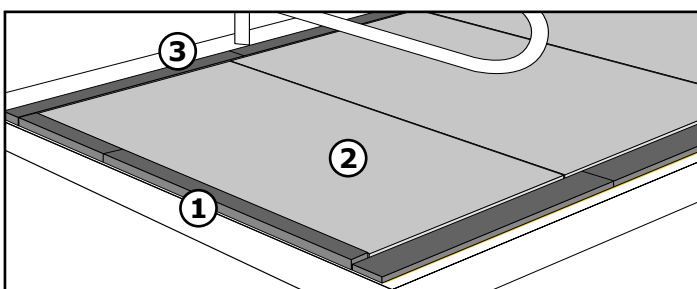

- 1 lay out thick, narrow sealing strips along the side edges - shorten sealing strips accordingly
- 2 place foam smoothly along rear and side sealing strips
- 3 lay thick, narrow sealing strips loosely edge to edge against foam



3 Roll out rubber cover

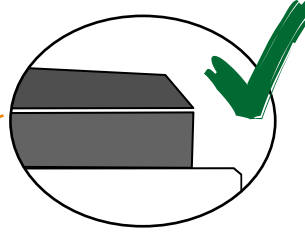
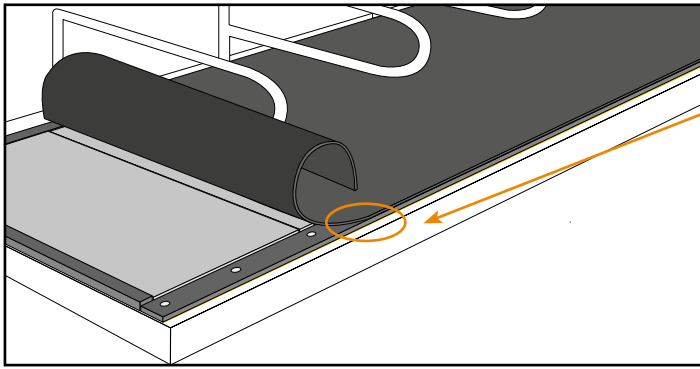

flush with the rear sealing strip

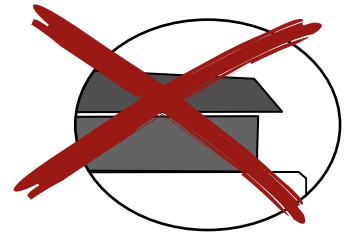

rubber cover may not overlap rearwards

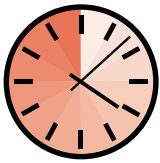

let the rolled out rubber cover rest in the house climate for **at least 12 hours** (-> to relieve tension)

4 Fastening

> nail plugs \varnothing 10 x 80 mm

i Start from the middle of the roll and fasten to the right and to the left

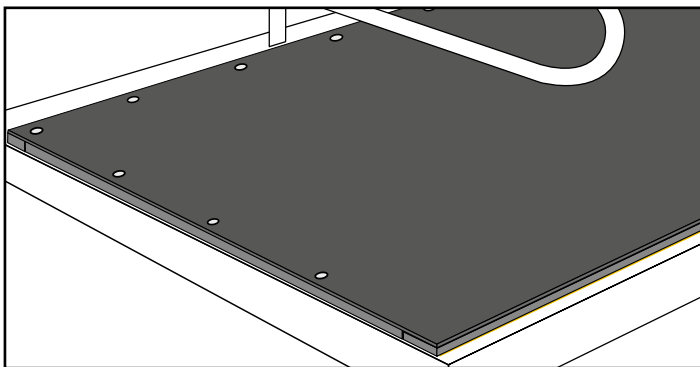

fasten through rubber cover and sealing strips **at the front and side edge**

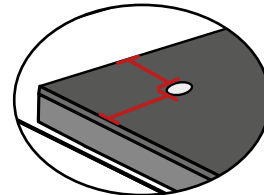

distance from edge: each about 2.5 cm

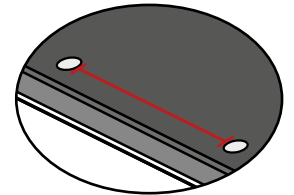

distance between fastenings: about 40 cm

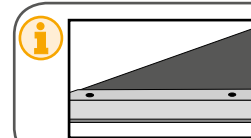
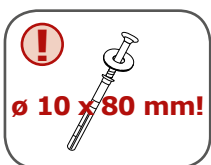

If using a steel bar (additional charge!) all distances are fixed through the pre-cut holes

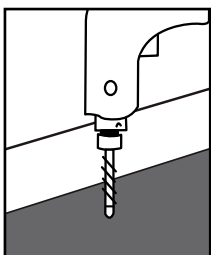

drill

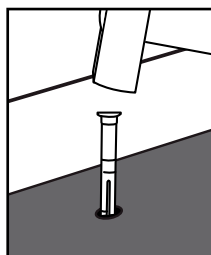

pound the plastic plugs in flush

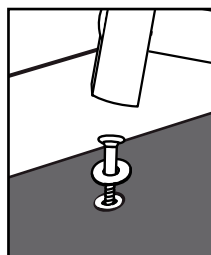

pound in nails and washers until they are seated evenly fast and are slightly countersunk